



High-pressure block ball valve HBA-D, stainless steel

With male thread

DN 4 - 25 mm PN max. 500 bar

- Series**
- 02 – male thread on both sides for non-soldering compression fittings with cutting ring DIN 2353 – light-duty series
 - 03 – male thread on both sides for non-soldering compression fittings with cutting ring DIN 2353 – heavy-duty series
 - 05 – male thread on both sides flat sealing for pipe thread DIN EN ISO 228 - 1
 - 44 – male thread on both sides flat sealing NPT ANSI/ASME B 1.20.1

Face-to-face lengths DIN 3202 – 5 series V1

Temperature range Standard: -10°C to +90°C
On request: -50°C to +250°C

Range of use Liquids: Liquids group 1 and 2 according to PED 2014/68/EU Article 13
Gases: Liquids group 1 and 2 according to PED 2014/68/EU Article 13
As a matter of principle, the resistance to the flow medium must be ensured.

Technical specification The HBA-D type ball valve consists of a block body with connector screwed in on both sides. The stem is fitted blowout-proof. Actuators can be attached by means of an extension kit. This retrofit requirement must be specified when placing the order (additional charge).

Technical data HBA-D

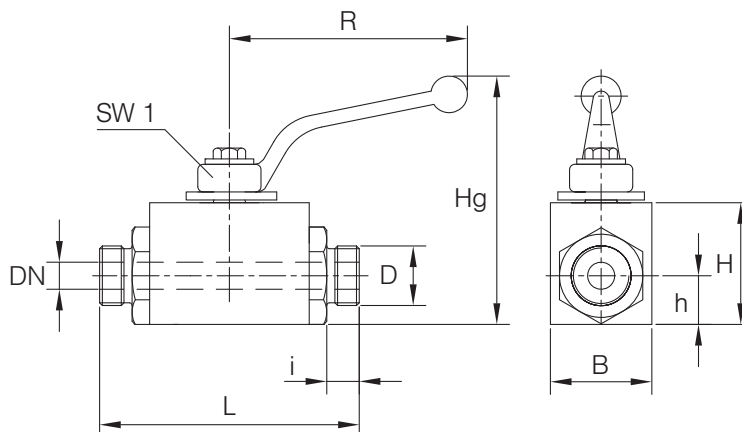

Series 02

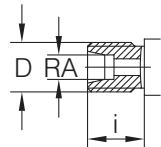

Series 03

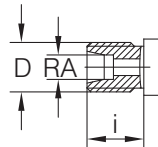

Series 05

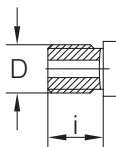

Series 44

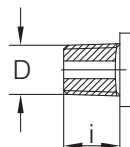

Series 02 (non-soldering compression fittings with cutting ring DIN 2353 light-duty series)

DN mm	RA mm	PN bar	D	i mm	L mm	B mm	H mm	h mm	Hg mm	R mm	SW1 mm	Weight kg
4	6	500	M 12x1.5	10	76	40	40	16	92	112	10	0.5
6	8	500	M 14x1.5	10	76	40	40	16	92	112	10	0.5
8	10	500	M 16x1.5	11	76	40	40	16	92	112	10	0.5
10	12	500	M 18x1.5	11	80	40	40	16	92	112	10	0.5
12	15	500	M 22x1.5	12	96	45	45	18	85	130	10	0.8
16	18	500	M 26x1.5	12	105	45	45	19	85	130	10	1.0
20	22	400	M 30x2	14	110	55	55	25	95	130	10	1.3
25	28	400	M 36x2	14	120	65	65	30	111	160	10	2.3

Note! The pressure rating of the pipe unions can deviate from the nominal pressure rating of the ball valve.

Series 03 (non-soldering compression fittings with cutting ring DIN 2353 – heavy-duty series)

DN mm	RA mm	PN bar	D	i mm	L mm	B mm	H mm	h mm	Hg mm	R mm	SW1 mm	Weight kg
4	8	500	M 16x1.5	12	76	40	40	16	92	112	10	0.5
6	10	500	M 18x1.5	12	76	40	40	16	92	112	10	0.5
8	12	500	M 20x1.5	12	76	40	40	16	92	112	10	0.5
10	14	500	M 22x1.5	14	80	40	40	16	92	112	10	0.5
12	16	500	M 24x1.5	14	96	45	45	19	85	130	10	0.8
16	20	500	M 30x2	16	105	45	45	19	85	130	10	1.0
20	25	400	M 36x2	18	110	55	55	25	95	130	10	1.3
25	30	400	M 42x2	20	132*	65	65	30	111	160	10	2.3

* Deviating from the length V1, where necessary request special version in length V1.

Note! The pressure rating of the pipe unions can deviate from the nominal pressure rating of the ball valve.

Series 05 (flat sealing male pipe thread DIN EN ISO 228-1)

DN mm	PN bar	D	i mm	L mm	B mm	H mm	h mm	Hg mm	R mm	SW1 mm	Weight kg
4	500	G1/8"	10	76	40	40	11.5	61.5	76	7	0.3
6	500	G1/4"	11	77*	40	40	11.5	61.5	76	7	0.3
8	500	G3/8"	12	76	40	40	16.0	92.0	112	10	0.5
10	500	G1/2"	12	82*	40	40	16.0	92.0	112	10	0.5
15	400	G3/4"	14	100*	45	45	22.0	90.0	130	10	1.0
20	500	G1"	16	109*	55	55	25.0	95.0	130	10	1.3
25	500	G1 1/4"	18	129*	65	65	30.0	113.0	160	10	2.3

*Deviating from the length V1, where necessary request special version in length V1.

Series 44 (flat sealing NPT – male thread ANSI/ASME B 1.20.1)

DN mm	PN bar	D	i mm	L mm	B mm	H mm	h mm	Hg mm	R mm	SW1 mm	Weight kg
4	500	NPT 1/8"	9.5	73*	40	40	16	92	112	10	0.5
6	500	NPT 1/4"	14.5	88*	40	40	16	92	112	10	0.5
8	500	NPT 3/8"	14.5	89*	40	40	16	92	112	10	0.5
10	500	NPT 1/2"	19.0	93*	40	40	16	92	112	10	0.5
15	500	NPT 3/4"	19.0	113*	45	45	19	85	130	10	1.0
20	400	NPT 1"	24.0	125*	55	55	25	95	130	10	1.3
25	400	NPT 1 1/4"	24.5	141*	65	65	30	111	160	10	2.3

*Deviating from the length V1, where necessary request special version in length V1.

Example of order: Ball valve type HBA-D DN 12 made of stainless steel with male thread for non-soldering compression fittings with cutting ring DIN 2353 – light-duty series (Series 02)

HBA-D 12 02

Parts list HBA-D

Pos.	Designation	Material*
10	Body	Stainless steel
20	Fitting	Stainless steel
30	Ball	Stainless steel
40	Seal	POM
50	Stop washer	Stainless steel
60	Stem	Stainless steel
80	O-ring	NBR
90	Hand lever	Zinc die-casting
100	O-ring	NBR
110	Bolt	
120	Washer	
130	Sliding ring	PTFE
140	Stop pin	

*Standard (can vary according to nominal width), other materials on request.
Due to the design, not all items are used for all nominal widths.

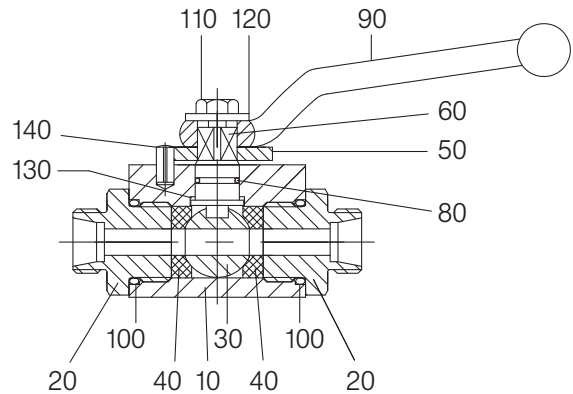

Please ask separately for requirements that exceed the standard conditions of use listed in this data sheet.

As a matter of principle, the safety information provided in the operating and servicing manual must be observed!

The operating and servicing manuals as well as the approval certificates can be downloaded at www.von-scheven.de.

We reserve the right to carry out technical modifications.