

## 2550 SERIES

Single Stage, High Sensitivity, Diaphragm Sensed  
Pressure Reducing Regulators



Premier 2550 Series regulators are single stage, increased sensitivity, diaphragm sensed, pressure reducing regulators, designed for inlet pressures up to 3000 psig (206.8 bar), and Cv 0.08 or 0.2. They are used to regulate a broad range of non-corrosive and corrosive media (*based on materials of construction*).

### FEATURES

- Large stainless steel diaphragm for increased sensitivity and reduced droop
- $\pm 1\%$  of outlet pressure range
- Stainless steel diaphragm minimizes inboard diffusion of air into the regulator
- Flow capacity (Cv): 0.08 or 0.2
- Optional panel mounting nuts
- Non-venting & self-venting designs
- Economical pricing
- Machined bar stock body eliminates porosity found in castings

**SOME APPLICATIONS WILL REQUIRE A CUSTOM SOLUTION.**  
CONTACT PREMIER INDUSTRIES TO REQUEST A MODIFICATION  
OR A CUSTOM DESIGN.

## SPECIFICATIONS

- **MAXIMUM INLET PRESSURE:**
  - 3000 PSIG (206.8 bar)
- **CONTROL PRESSURE RANGES:**
  - 0-10 PSIG (0 - 0.69 bar)
  - 0-25 PSIG (0 - 1.72 bar)
  - 0-50 PSIG (0 - 3.45 bar)
  - 0-100 PSIG (0 - 6.89 bar)
  - 0-150 PSIG (0 - 10.34 bar)
  - 0-250 PSIG (0 - 17.24 bar)  
(P/N: 50-11487 only)
- **FLOW (Cv):** 0.08 (standard) or 0.2

## MATERIALS OF CONSTRUCTION

- **BODY:**
  - 316 Stainless Steel
  - SAE 360 Brass
  - SAE 360 Brass/Nickel Plated\*  
\*Contact factory for pricing
  - 6061-T6 Aluminum/Clear Anodized
- **BONNET:**
  - SAE 360 Brass/Nickel Plated
  - 6061-T6 Aluminum/Clear Anodized
- **DIAPHRAGM:**
  - 316 Stainless Steel
  - Neoprene
- **DIAPHRAGM SEAL:**
  - PTFE
- **MAIN VALVE SEAT:**
  - PTFE

## PORTING

- **STANDARD INLET/OUTLET:**
  - 1/4-18 FNPT
  - Contact factory for other options
- **BONNET:**
  - SAE 360 Brass/Nickel Plated\*  
\*Contact factory for pricing
  - 6061-T6 Aluminum/Clear Anodized
- **DIAPHRAGM:**
  - 316 Stainless Steel
  - Neoprene
- **DIAPHRAGM SEAL:**
  - PTFE
- **MAIN VALVE SEAT:**
  - PTFE

## OPTIONS

- Gauges (optional) 2" diameter
- Private label
- Panel mounting nut
- NACE compliant design P/N: 50-12911

PART NUMBER 50-11487 | Shown below with standard porting

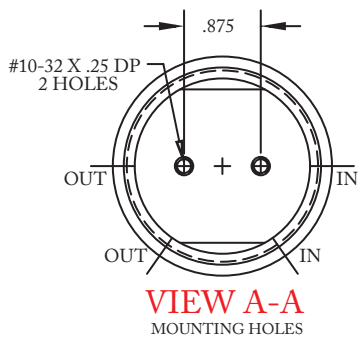
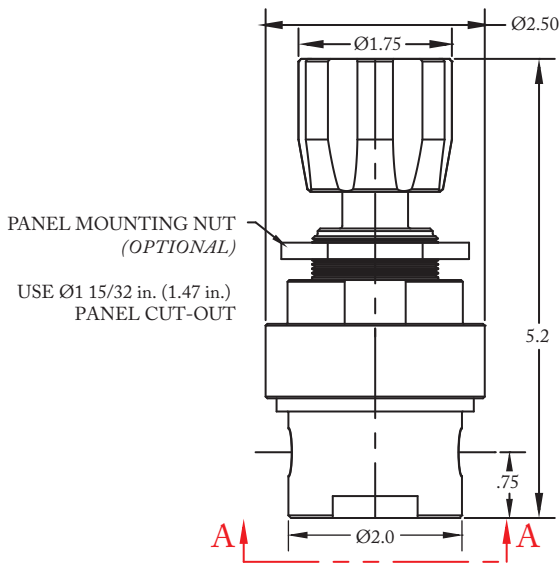
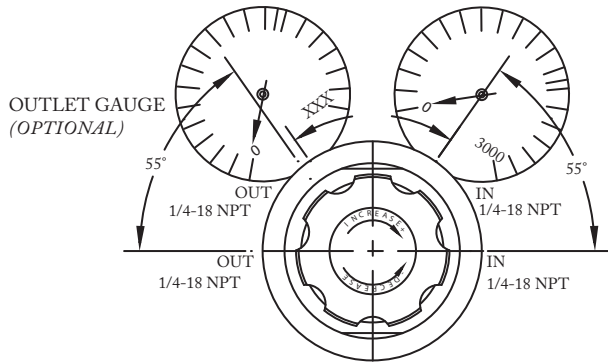













PART #	-	1	2	3	4	5	6	7
50-11487	-							

**NON-VENTING**

1	BODY MATERIAL & FINISH
2	316 Stainless Steel, cleaned per spec #515
3	6061-T6 Aluminum, Clear Anodized
5	SAE 360 Brass, Nickel Plated <i>Contact factory for pricing</i>
8	SAE 360 Brass
2	DIAPHRAGM MATERIAL
Blank	316 Stainless Steel Diaphragm
N	Neoprene diaphragm
3	OUTLET PRESSURE (outlet gauge range, if supplied)
0	0 - 10 PSIG / 0 - 0.69 bar (per application)
1	0 - 25 PSIG / 0 - 1.72 bar (0-60 PSIG gauge)
2	0 - 50 PSIG / 0 - 3.45 bar (0-100 PSIG gauge)
3	0 - 100 PSIG / 0 - 6.89 bar (0-160 PSIG gauge)
4	0 - 150 PSIG / 0 - 10.34 bar (0-200 PSIG gauge)
5	0 - 250 PSIG / 0 - 17.24 bar (0-400 PSIG gauge)

4	GAUGES
Blank	no gauges (standard)
A	2" diameter, inlet only, stainless steel wetted gauge
B	2" diameter, outlet only, stainless steel wetted gauges
C	2" diameter, inlet & outlet, stainless steel wetted gauges
D	2" diameter, inlet only, brass wetted gauges
E	2" diameter, outlet only, brass wetted gauges
F	2" diameter, inlet & outlet, brass wetted gauges
H	2" diameter, outlet only, brass wetted/ chrome plated gauges
J	2" diameter inlet & outlet brass wetted/ chrome plated gauges
5	PANEL MOUNTING NUT (optional)
5	Mounting nut
8	No nut (standard)

6	PORTING OPTIONS
Blank	 (Standard)
A	
B	
C	
D	
E	
F	
G	
H	
I	
J	
K	
L	

7	MAIN VALVE Cv
Blank	Cv 0.08 (standard)
Y	Cv 0.20 w/o filter (hydraulic service)
Z	Cv 0.20













*Contact factory for material certifications. Fees may apply.*

PART #	-	1	2	3	4	5	6	7
50-13281	-							

**SELF-VENTING**

1	BODY MATERIAL & FINISH
2	316 Stainless Steel, <i>cleaned per spec #515</i>
3	6061-T6 Aluminum, <i>Clear Anodized</i>
5	SAE 360 Brass, <i>Nickel Plated</i> <i>Contact factory for pricing</i>
8	SAE 360 Brass
2	DIAPHRAGM MATERIAL
Blank	316 Stainless Steel Diaphragm
N	Neoprene diaphragm
3	OUTLET PRESSURE <i>(outlet gauge range, if supplied)</i>
0	0 - 10 PSIG / 0 - 0.69 bar <i>(per application)</i>
1	0 - 25 PSIG / 0 - 1.72 bar <i>(0-60 PSIG gauge)</i>
2	0 - 50 PSIG / 0 - 3.45 bar <i>(0-100 PSIG gauge)</i>
3	0 - 100 PSIG / 0 - 6.89 bar <i>(0-160 PSIG gauge)</i>
4	0 - 150 PSIG / 0 - 10.34 bar <i>(0-200 PSIG gauge)</i>

4	GAUGES
Blank	no gauges <i>(standard)</i>
A	2" diameter, inlet only, stainless steel wetted gauge
B	2" diameter, outlet only, stainless steel wetted gauges
C	2" diameter, inlet & outlet, stainless steel wetted gauges
D	2" diameter, inlet only, brass wetted gauges
E	2" diameter, outlet only, brass wetted gauges
F	2" diameter, inlet & outlet, brass wetted gauges
H	2" diameter, outlet only, brass wetted/ chrome plated gauges
J	2" diameter inlet & outlet brass wetted/ chrome plated gauges
5	PANEL MOUNTING NUT <i>(optional)</i>
5	Mounting nut
8	No nut <i>(standard)</i>

6	PORTING OPTIONS
Blank	 <i>(Standard)</i>
A	
B	
C	
D	
E	
F	
G	
H	
I	
J	
K	
L	

7	MAIN VALVE Cv
Blank	Cv 0.08 <i>(standard)</i>
Z	Cv 0.20

Contact factory for material certifications. Fees may apply.